

# KS2 SAT Revision

## Ten for Ten

Easter Practice Booklet

**MATHEMATICS**

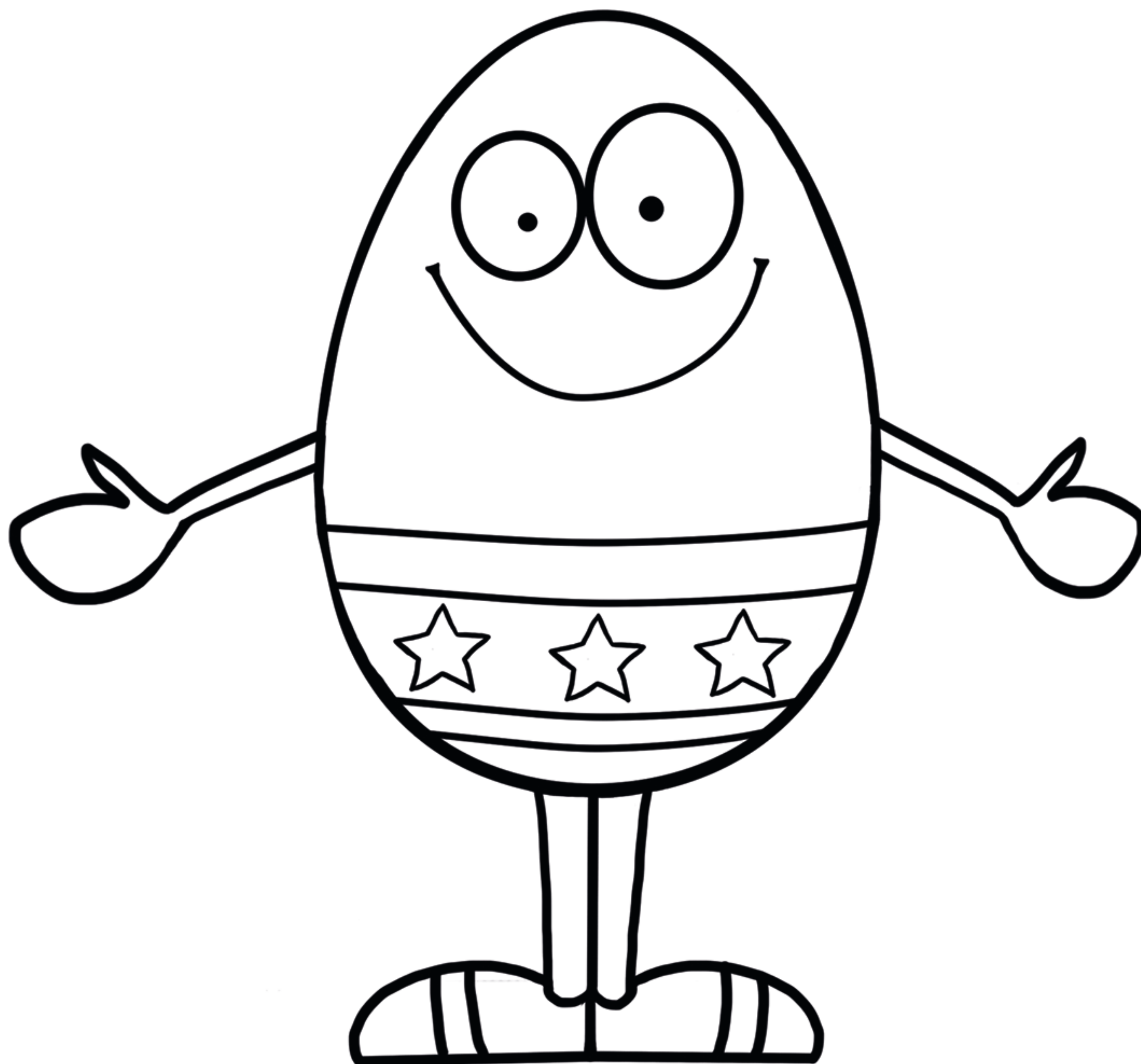

EGG-CEEDING

Name: \_\_\_\_\_



# **Ten for Ten**

## **Easter Practice Booklet**

### **KS2 Mathematics**

The SATs are just around the corner, but no need to panic! Just use this booklet to do your 10 minutes practice for 10 days during the Easter holiday and you'll be ready for action when you get back to school : D

Each day, after you've completed the arithmetic and the reasoning section, mark your work yourself using the answer pack or go through it with your parents. This is important so you know what you can do and what you still need to work on.

Good luck!





# Day 2 - Arithmetic



1

$$50\% \text{ of } \frac{1}{3} =$$

A large grid of red lines for working out the calculation. A blue rectangular box is drawn on the right side of the grid, intended for the final answer.

1 mark

2

$$40,000 \times 500 =$$

A large grid of red lines for working out the calculation. A blue rectangular box is drawn on the right side of the grid, intended for the final answer.

1 mark

3

$$\boxed{\phantom{00000}} = 1 - 0.089$$

A large grid of red lines for working out the calculation. A blue rectangular box is drawn on the right side of the grid, intended for the final answer.

1 mark

4

$$\frac{3}{6} + \frac{1}{6} =$$



1 mark

5

$$85\% \text{ of } 480 =$$



1 mark

6

$$7,609 \times 44 =$$

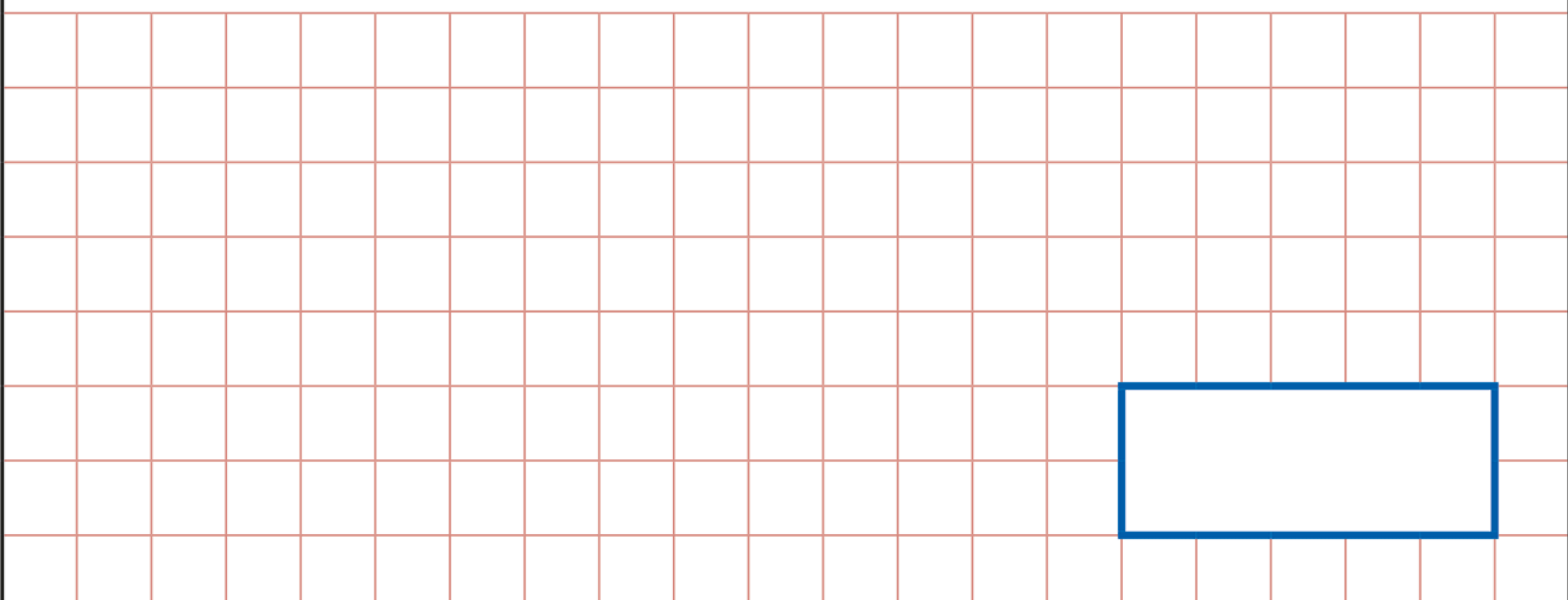

1 mark





4

$$9,924 \div 6 =$$

1 mark

5

$$9 \times 3\frac{1}{4}$$

1 mark

6

$$\frac{6}{4} \times 130 =$$

1 mark



4

$$24 \times 24 =$$

1 mark

5

$$1\frac{1}{5} + 1\frac{1}{6} =$$

1 mark

6

$$2 \times 3 \times 4 \times 5 =$$

1 mark





# Day 6 - Arithmetic



1

$$0.69 \div 2 =$$

A large grid of red lines for working out the calculation. A blue rectangular box is drawn on the right side of the grid, intended for the final answer.

1 mark

2

$$3^3 + 4^3 + 5^3 =$$

A large grid of red lines for working out the calculation. A blue rectangular box is drawn on the right side of the grid, intended for the final answer.

1 mark

3

$$\boxed{\phantom{000}} = \frac{4}{6} + \frac{2}{6}$$

A large grid of red lines for working out the calculation. A blue rectangular box is drawn on the right side of the grid, intended for the final answer.

1 mark







4

$$28 - 5 \times 3 =$$

1 mark

5

$$35\% \times 440 =$$

1 mark

6

4 3 | 1 6 2 9 7

Show  
your  
method

2 marks



4

$$\frac{4}{5} + \frac{5}{15} =$$

1 mark

5

$$\frac{6}{7} \div 2 =$$

1 mark

6

$$2\frac{1}{2} + \frac{1}{3} =$$

1 mark

# Day 9 - Arithmetic



1

$$345 \times 5 \times 4 =$$

A large grid of red lines for working out the calculation. A blue rectangular box is drawn on the right side of the grid, intended for the final answer.

1 mark

2

$$3 - 7 \times 9 =$$

A large grid of red lines for working out the calculation. A blue rectangular box is drawn on the right side of the grid, intended for the final answer.

1 mark

3

$$= 1,320 \div 11$$

A large grid of red lines for working out the calculation. A blue rectangular box is drawn on the right side of the grid, intended for the final answer.

1 mark

4

$90\% \text{ of } 2,000 =$

1 mark

5

$32 \overline{) 5792}$

Show  
your  
method

2 marks

6

$\frac{3}{4} + \frac{3}{12} =$

1 mark

# Day 10 - Arithmetic



1

$$-19 + 3,078 =$$

A large grid of red lines on a white background, intended for showing the steps of the calculation. A blue rectangular box is drawn on the right side of the grid, serving as a space for the final answer.

1 mark

2

$$3 \times 72 + 7 \times 72 =$$

A large grid of red lines on a white background, intended for showing the steps of the calculation. A blue rectangular box is drawn on the right side of the grid, serving as a space for the final answer.

1 mark

3

$$1.45 \times 7$$

A large grid of red lines on a white background, intended for showing the steps of the calculation. A blue rectangular box is drawn on the right side of the grid, serving as a space for the final answer.

1 mark

4

$$\frac{4}{6} - \frac{1}{73} =$$



1 mark

5

$$2,598 \times 75 =$$



1 mark

6

$$20.1 \div 1000 =$$

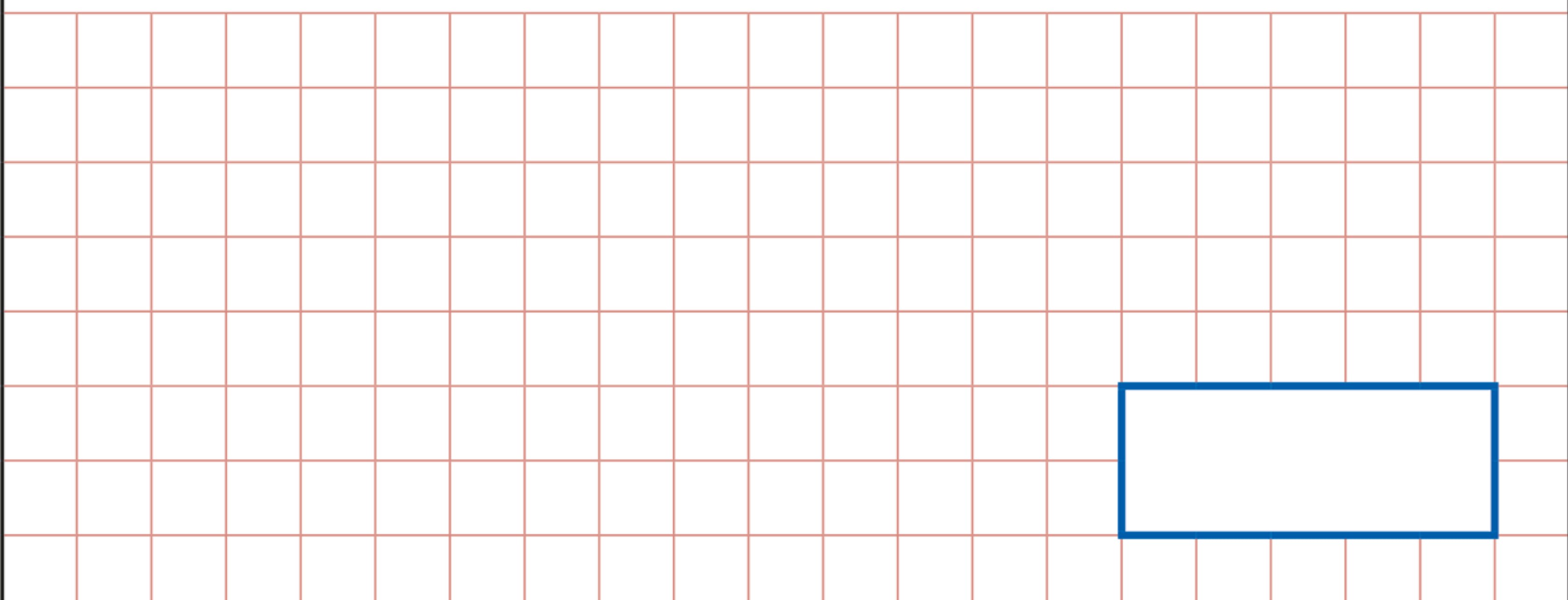

1 mark

# Day 1 - Reasoning



1 This diagram shows two **identical** rectangles on coordinate axes.

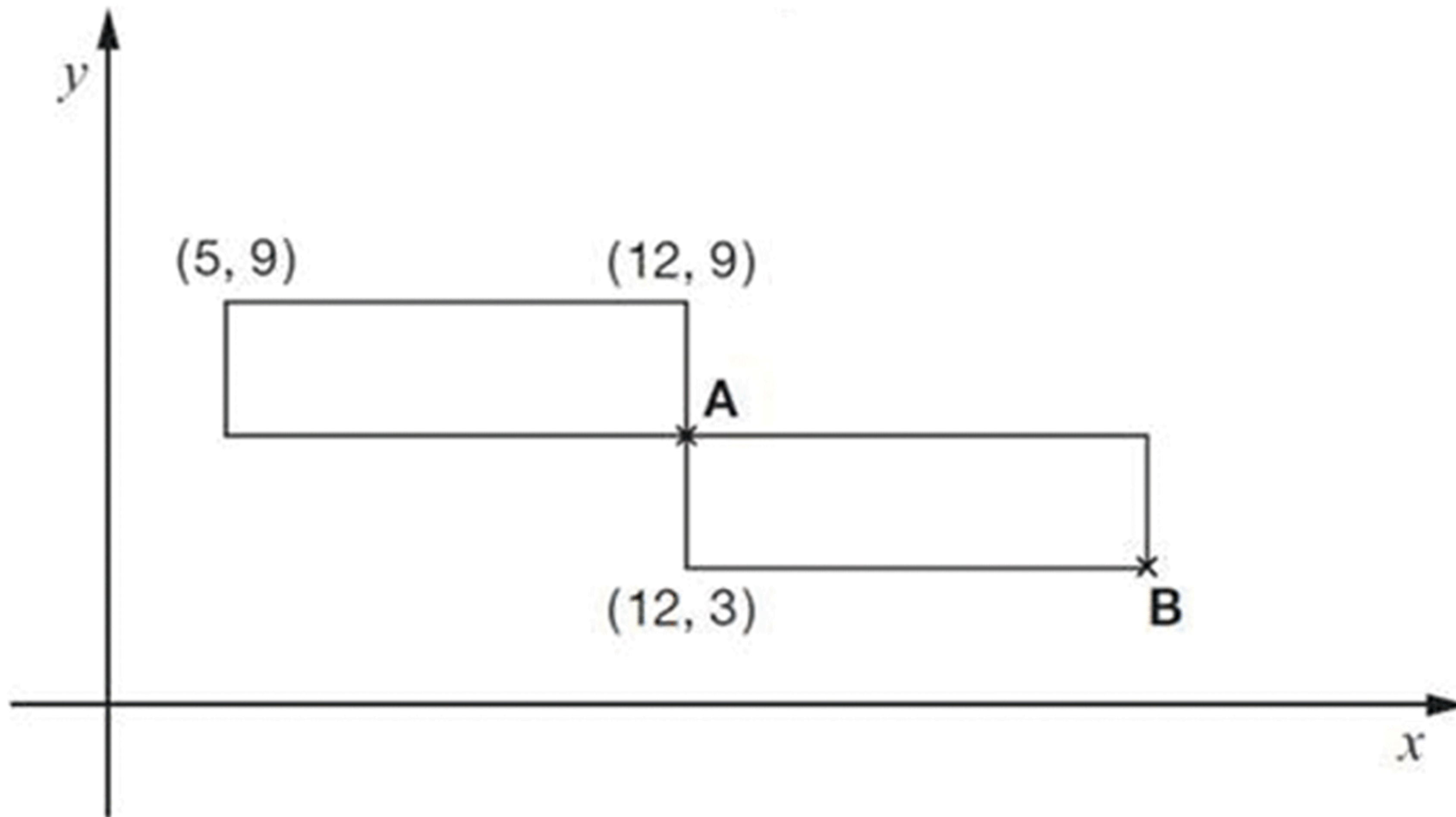

Write the **coordinates** of point **A** and point **B**.

A is

B is

2  $n$  stands for a whole number.

$2n$  is greater than 30

$5n$  is less than 100

Write **all** the numbers that  $n$  stands for.

---



3 Write the missing fraction.

$$\frac{1}{3} + \frac{1}{4} + \boxed{\phantom{000}} = 1$$

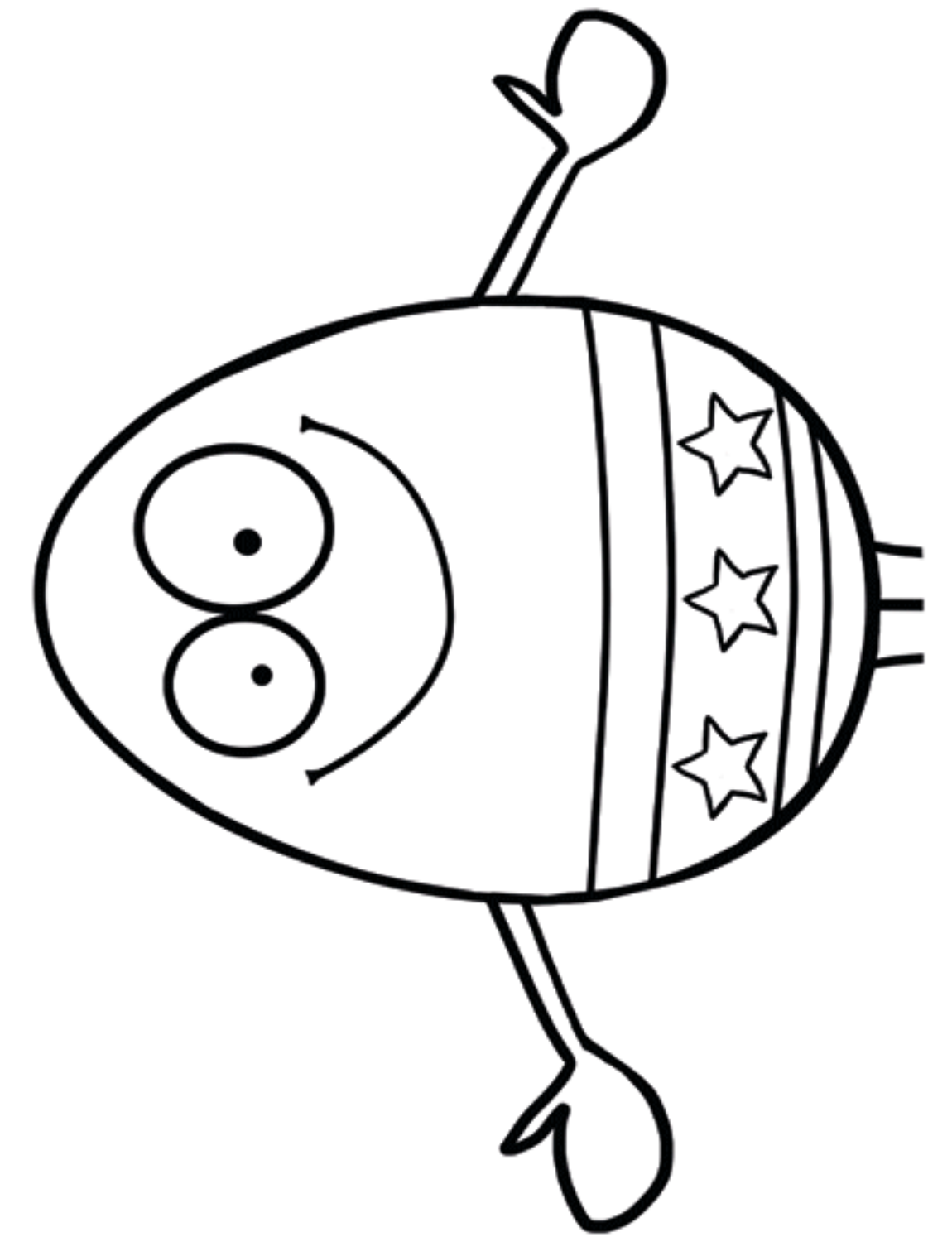

4 What is 10% of a half?



What percentage of 20 is 19?



5 Mark with arrows the points **-1.5** and **0.45** on the number line.



# Day 2 - Reasoning



1 The arrow below points to the **mean** of the three numbers shown by crosses.

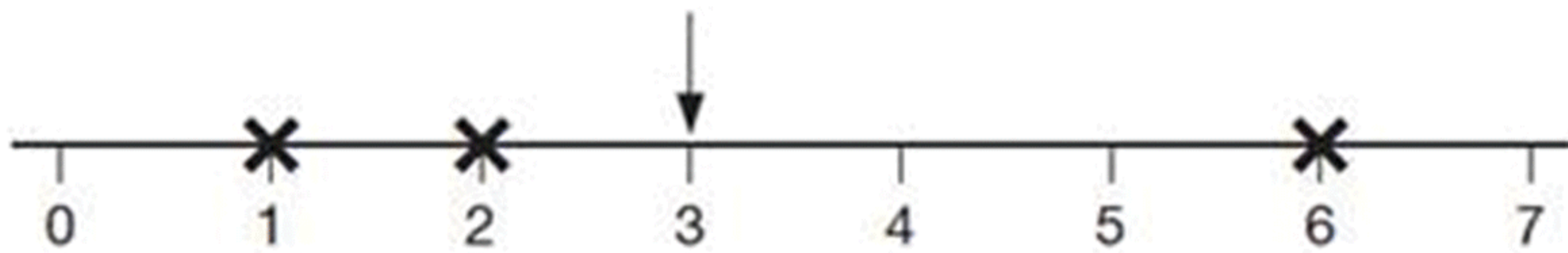

(a) Draw an arrow that points to the mean of the three numbers shown below.

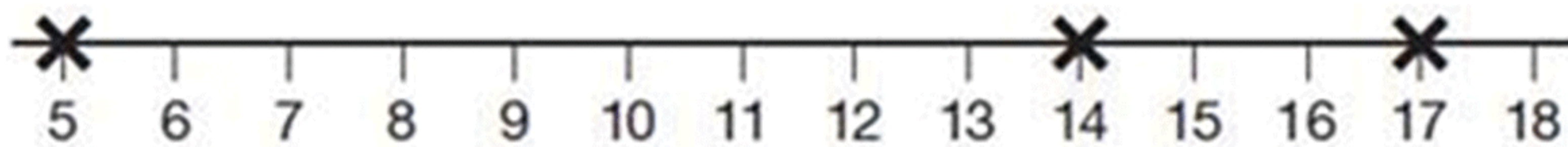

(b) The arrow below points to the mean of three numbers.

One of the numbers is missing.

Draw a cross to show the position of the missing number.



2 Jack has two **square-based pyramids** that are the same size.

He sticks the square faces together to make a new 3-D shape.

How many **faces** and how many **edges** does his new 3-D shape have?

faces
-------

and

edges
-------

3 Millie has some star-shaped tiles.

Each edge of a tile is 5 centimetres long.

Not actual size

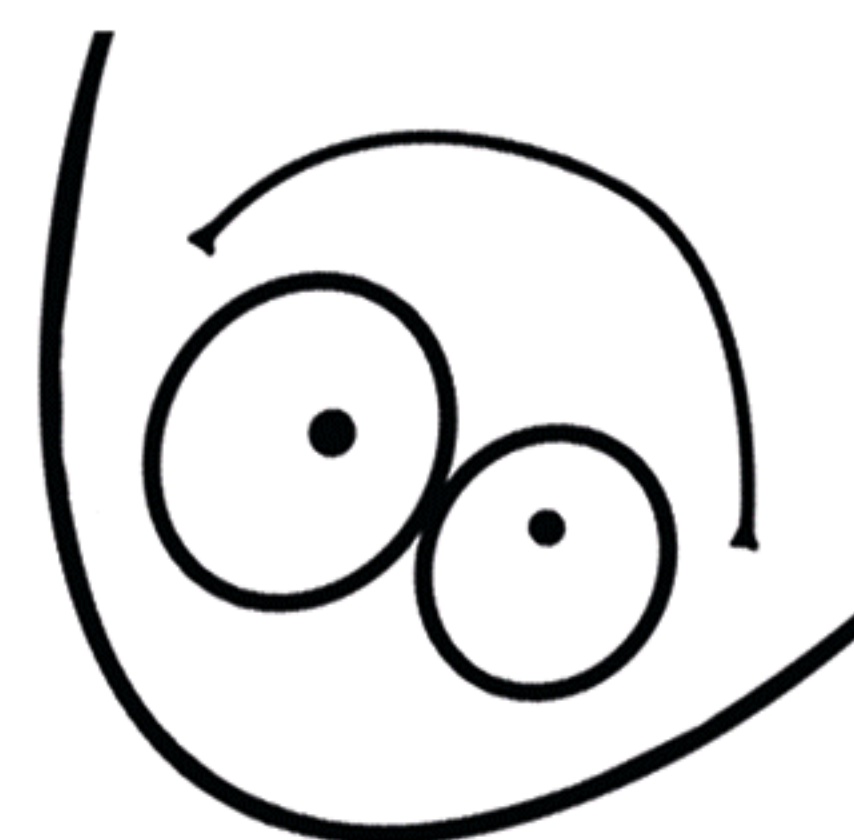
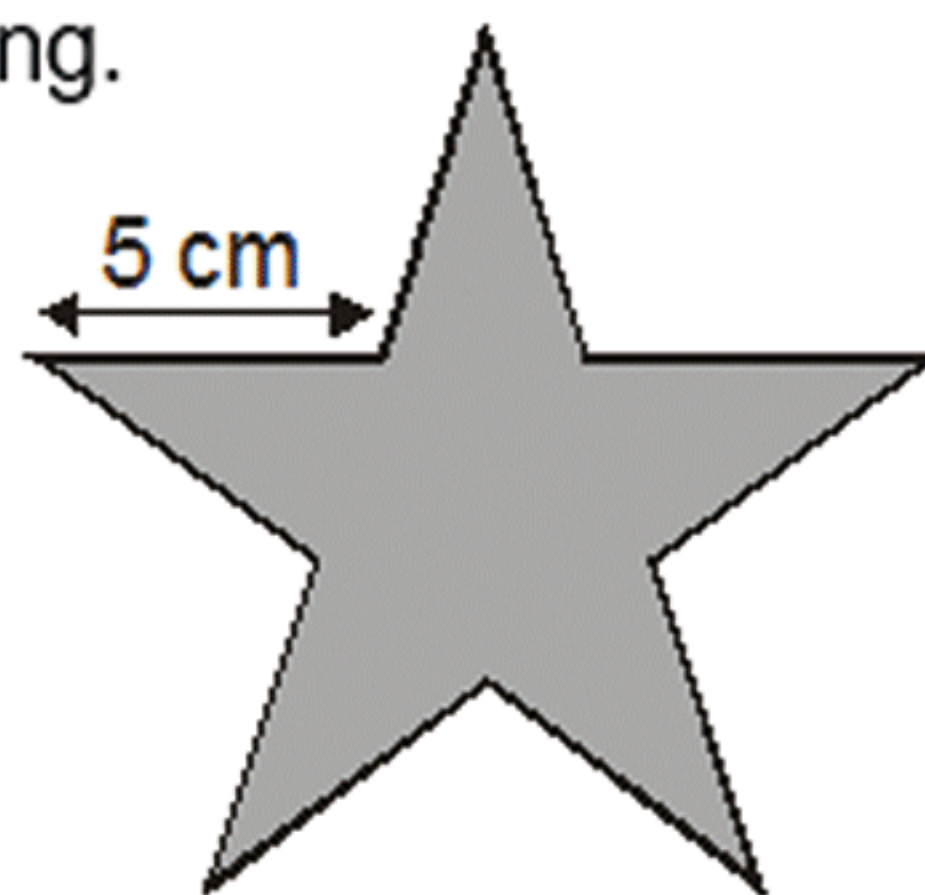

She puts two tiles together to make this shape.



Work out the perimeter of Millie's shape.

A small pencil icon is positioned to the left of a rectangular box. The box is empty and has the label "cm" written at the bottom right corner.

4 This is Kirsty's recipe for breakfast cereal.

- 50 grams of oats
- 30 grams of raisins
- 40 grams of nuts



If she uses 125 grams of oats, how many grams of raisins does she need?

Show your method

A large grid for showing the method. On the left side, there is a rounded rectangular box containing the text "Show your method". On the right side of the grid, there is a smaller rectangular box containing the letter "g".

# Day 3 - Reasoning



1 Miss Mills is making jam to sell at the school fair.

Strawberries cost £7.50 per kg.

Sugar costs 79p per kg.

10 glass jars cost £6.90

She uses 12 kg of strawberries and 10 kg of sugar to make 20 jars full of jam.

Calculate the total cost to make 20 jars full of jam.

Show your method

£

2 Write the missing number.

$$12.5 \div \square = 7.5 \div 1.5$$

3  $n = 22$

What is  $2n + 9$ ?

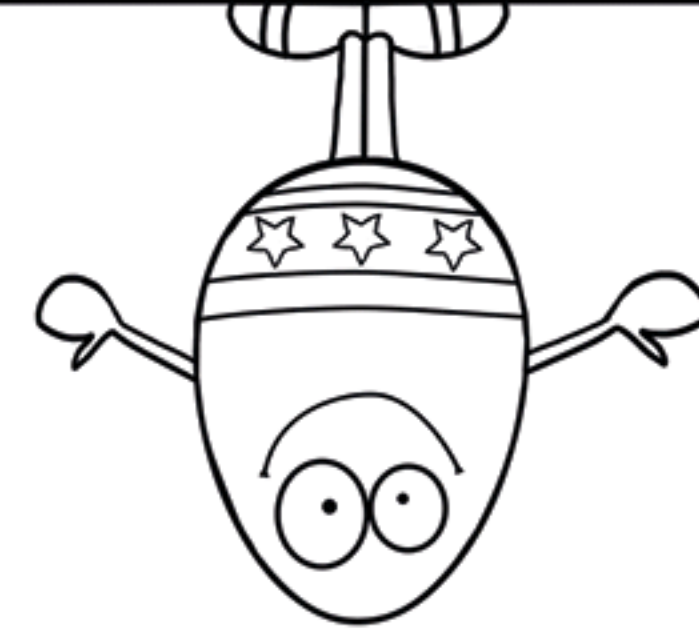

$2q + 4 = 100$

Work out the value of  $q$ .

$q =$

4 The diagram shows three **identical** shaded triangles on coordinate axes.

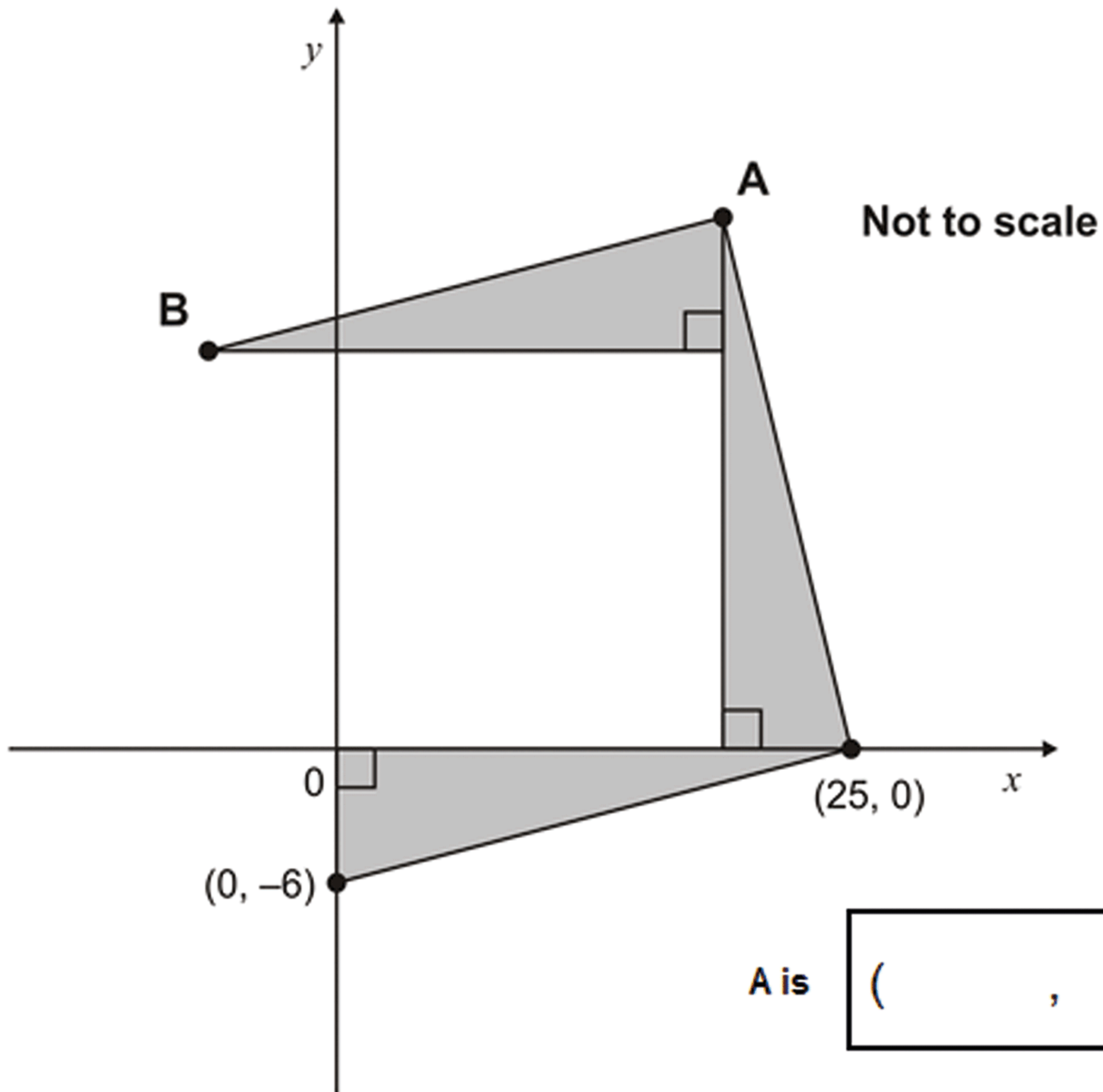

A is

What are the coordinates of A and B?

B is



3 Alfie has two sticks.

He puts them end to end.

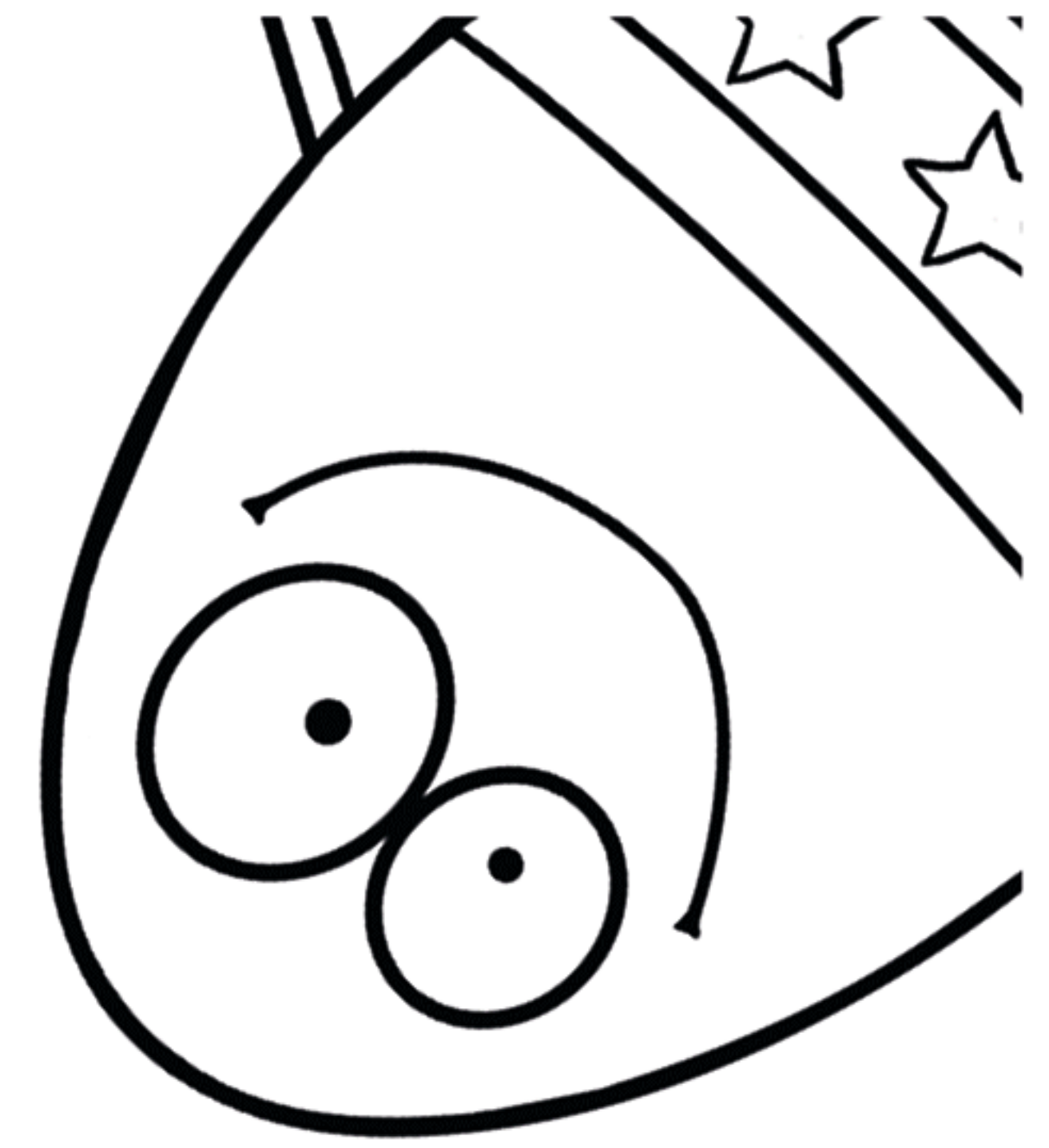
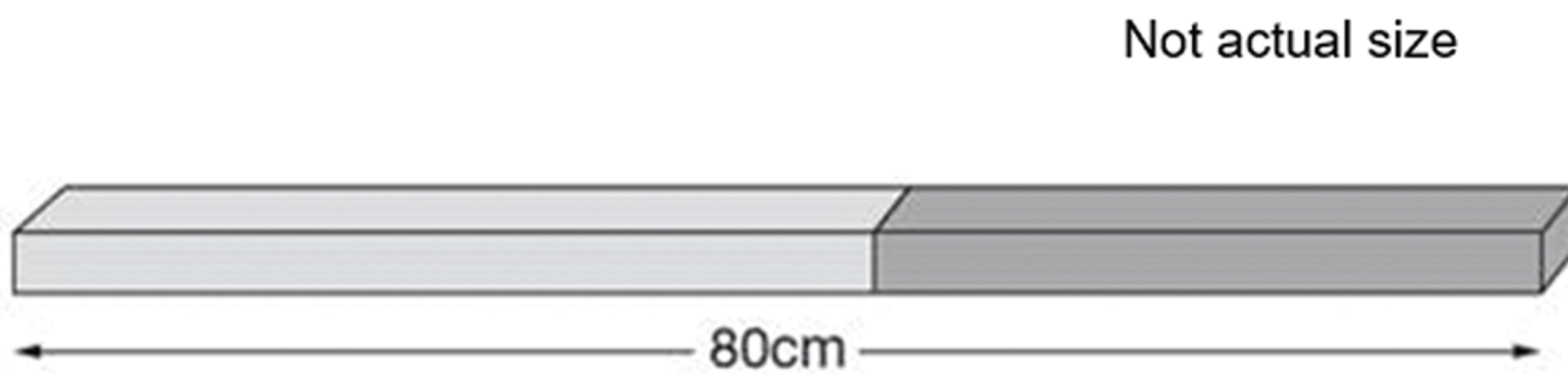

One stick is **10cm longer** than the other stick.

How long are the two sticks?

Show your method

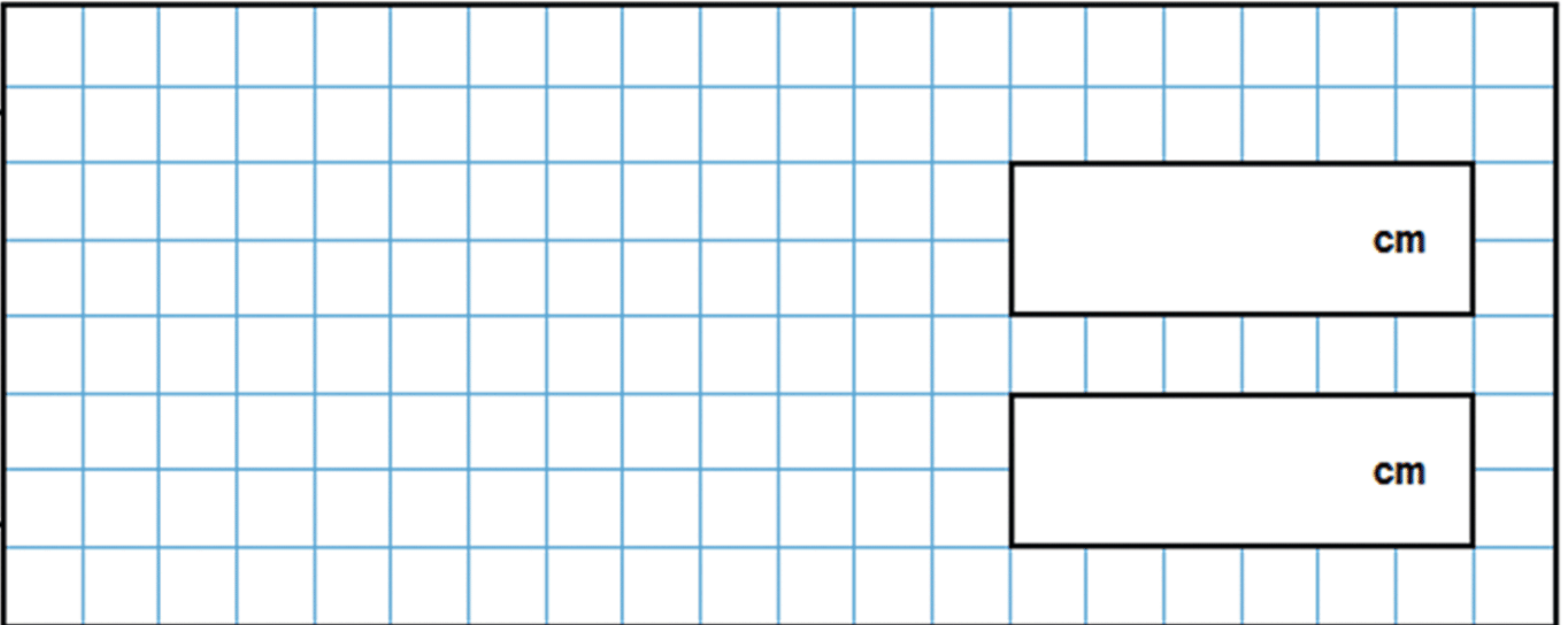

A large grid for showing the method. On the left side, there is a rounded rectangle containing the text 'Show your method'. On the right side of the grid, there are two horizontal rectangles. The top rectangle is labeled 'cm' and the bottom rectangle is also labeled 'cm'.

4 Three apples have a **mean** (average) mass of 100 grams.

The largest apple is removed.

The **mean** mass of the remaining two apples is 70 grams.

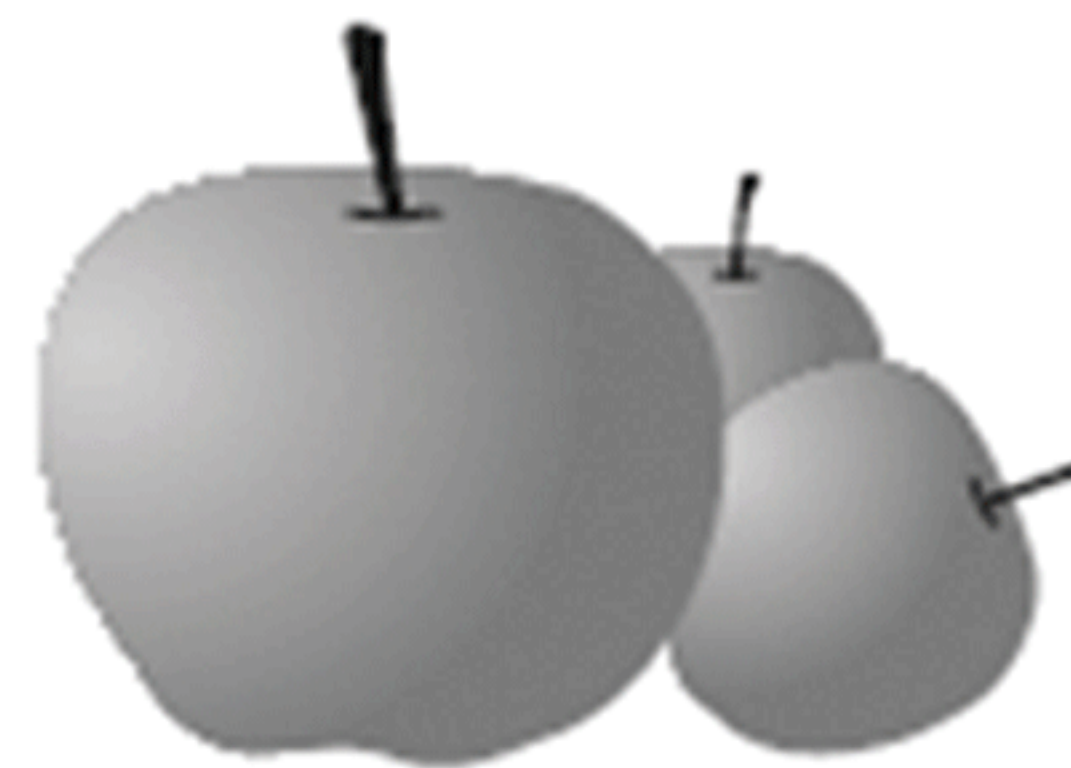

What is the mass of the largest apple?

# Day 5 - Reasoning



1 Write the missing number.

$$70 \div \boxed{\phantom{000}} = 3.5$$

2 This sequence of numbers goes up by 40 each time.

40      80      120      160      200      ...

This sequence continues.

Will the number 2140 be in the sequence?

Circle Yes or No.

 Yes / No

Explain how you know.

.....

.....

3 Here is part of the bus timetable from Riverdale to Mott Haven.

Riverdale	10:02	10:12	10:31	10:48
Kingsbridge	10:11	10:21	10:38	10:55
Fordham	10:28	10:38	10:54	11:11
Tremont	10:36	10:44	11:00	11:17
Mott Haven	10:53	11:01	11:17	11:34

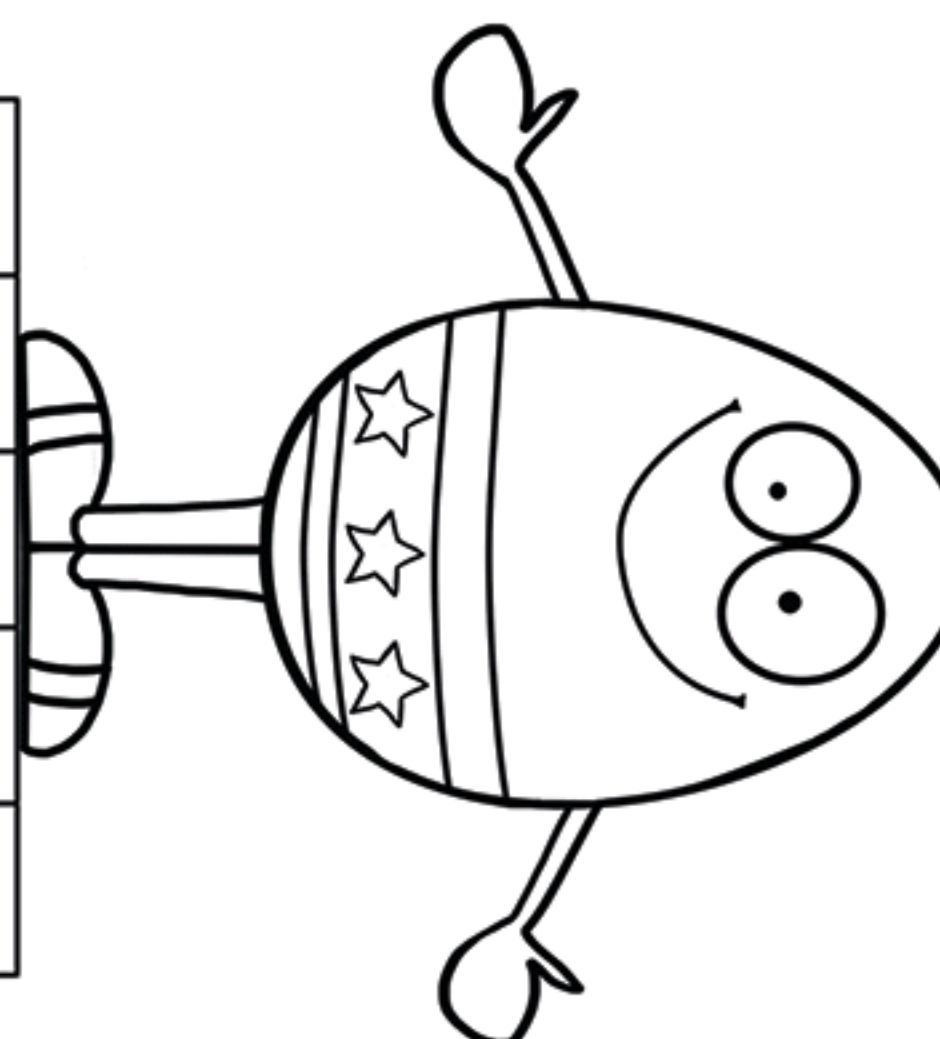

How many minutes does it take the 10:31 bus from Riverdale to reach Mott Haven?

Mr Evans is at Fordham at 10:30

What is the **earliest** time he can reach Tremont on the bus?



**4** Here is a diagram for sorting numbers.

Write these three numbers in the correct boxes.

You may not need to use all of the boxes.

**9    17    20**

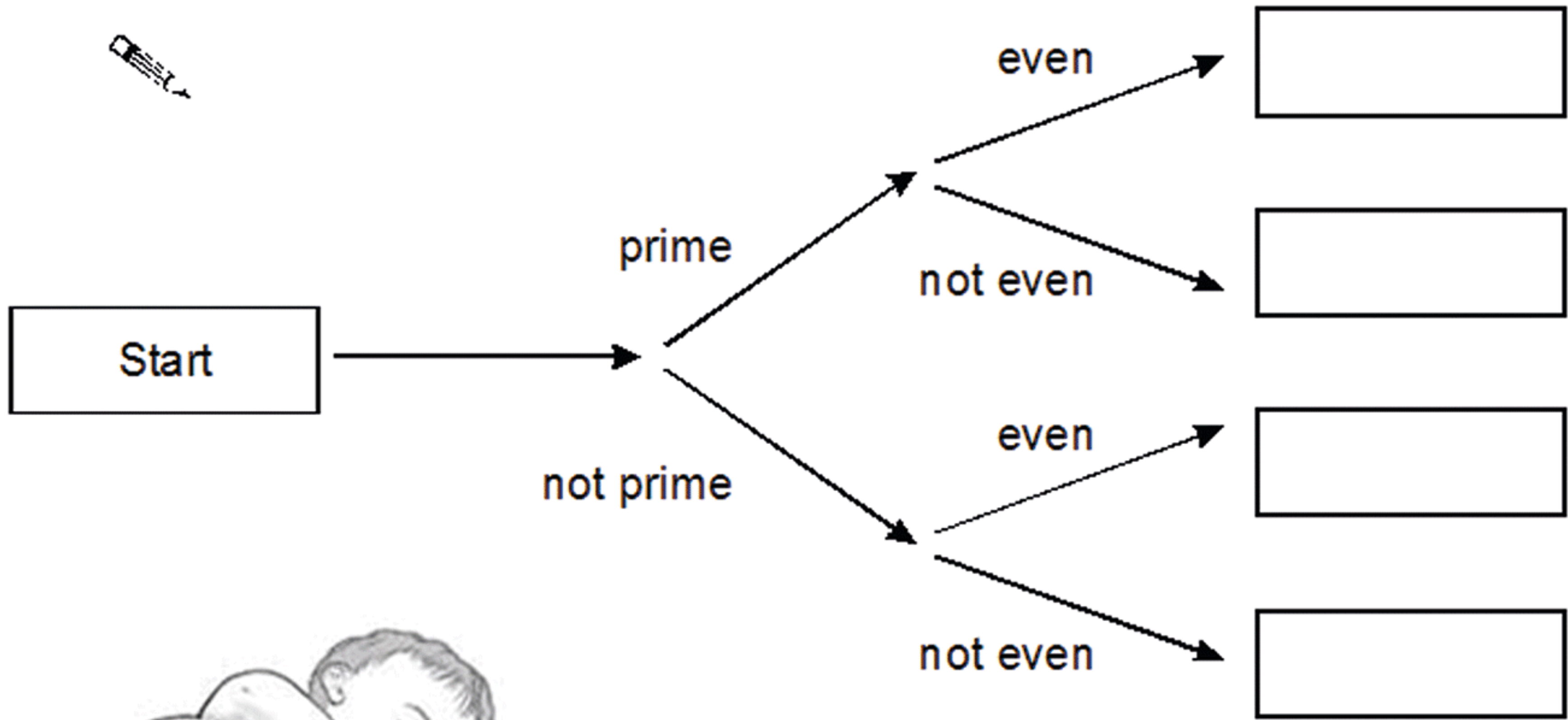

**5**



How many **days** old will the baby be when she has lived for **one million seconds**?

Show your method

days





# Day 7 - Reasoning



1 The area of a rugby pitch is 6,108 square metres.

A football pitch measures 112 metres long and 82 metres wide.

How much larger is the area of the football pitch than the area of the rugby pitch?

Show your method

square metres

2 An isosceles triangle has a perimeter of 12cm.

One of its sides is 5cm.

What could the length of each of the other two sides be?

Two different answers are possible.

Give **both** answers.

  cm and  cm

cm and  cm

3 This thermometer shows temperatures in both °C and °F.

Work out what **25°C** is in °F.

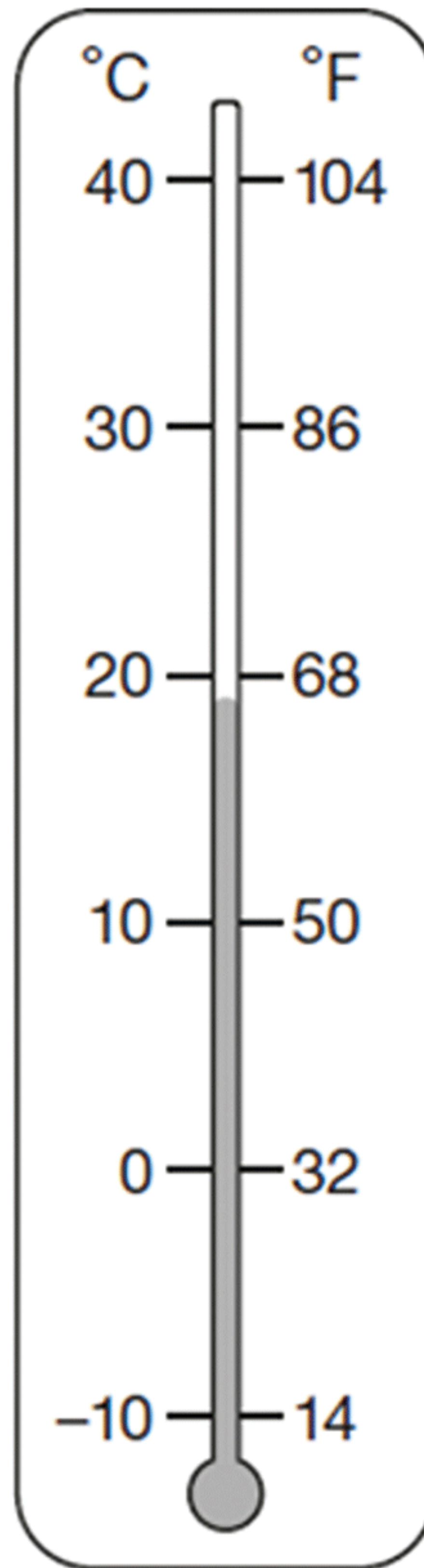

4 Here is a kite.

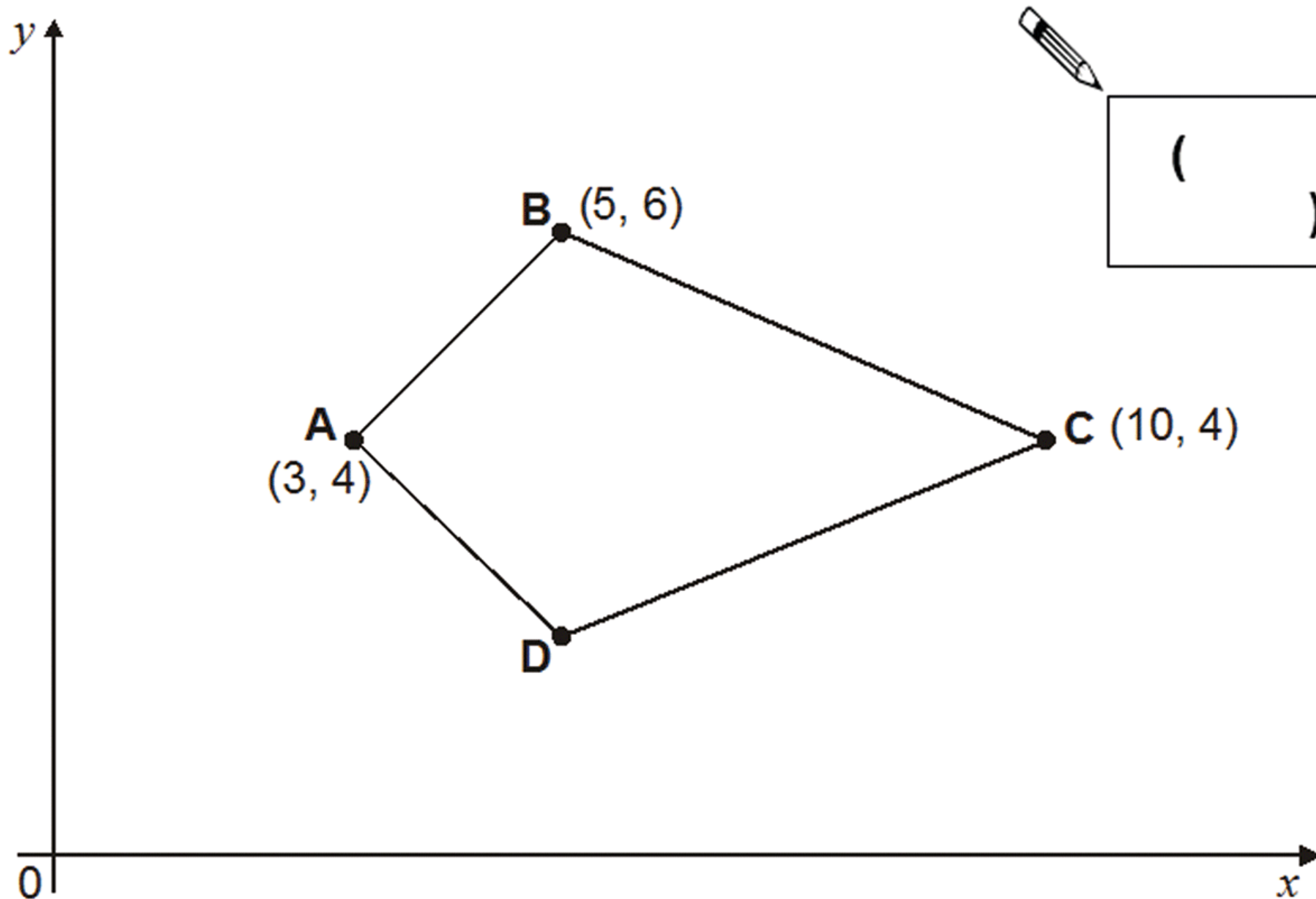



Write the coordinates of point **D**.

# Day 8 - Reasoning



- 1 The numbers in this sequence increase by 30 each time.

20    50    80    110    ...

The sequence continues in the same way.

Which number in the sequence will be **closest to 300**?

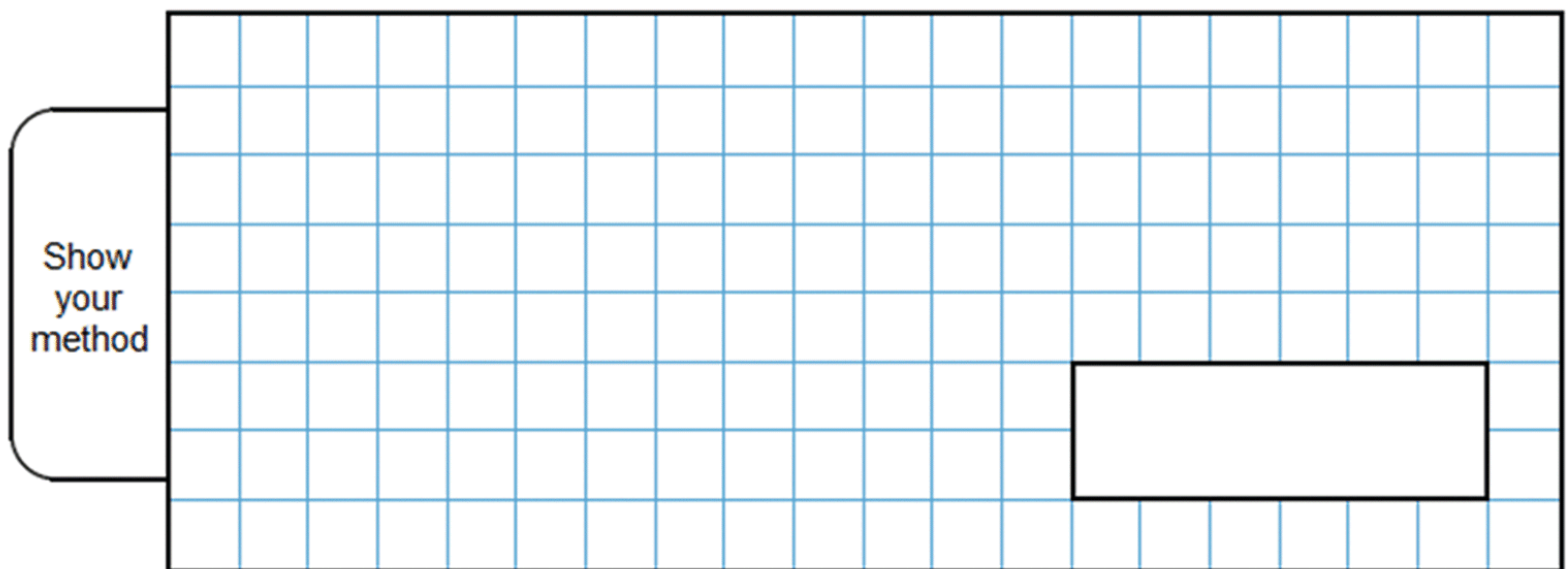

- 2 The diagram shows a shaded triangle inside a rectangle.

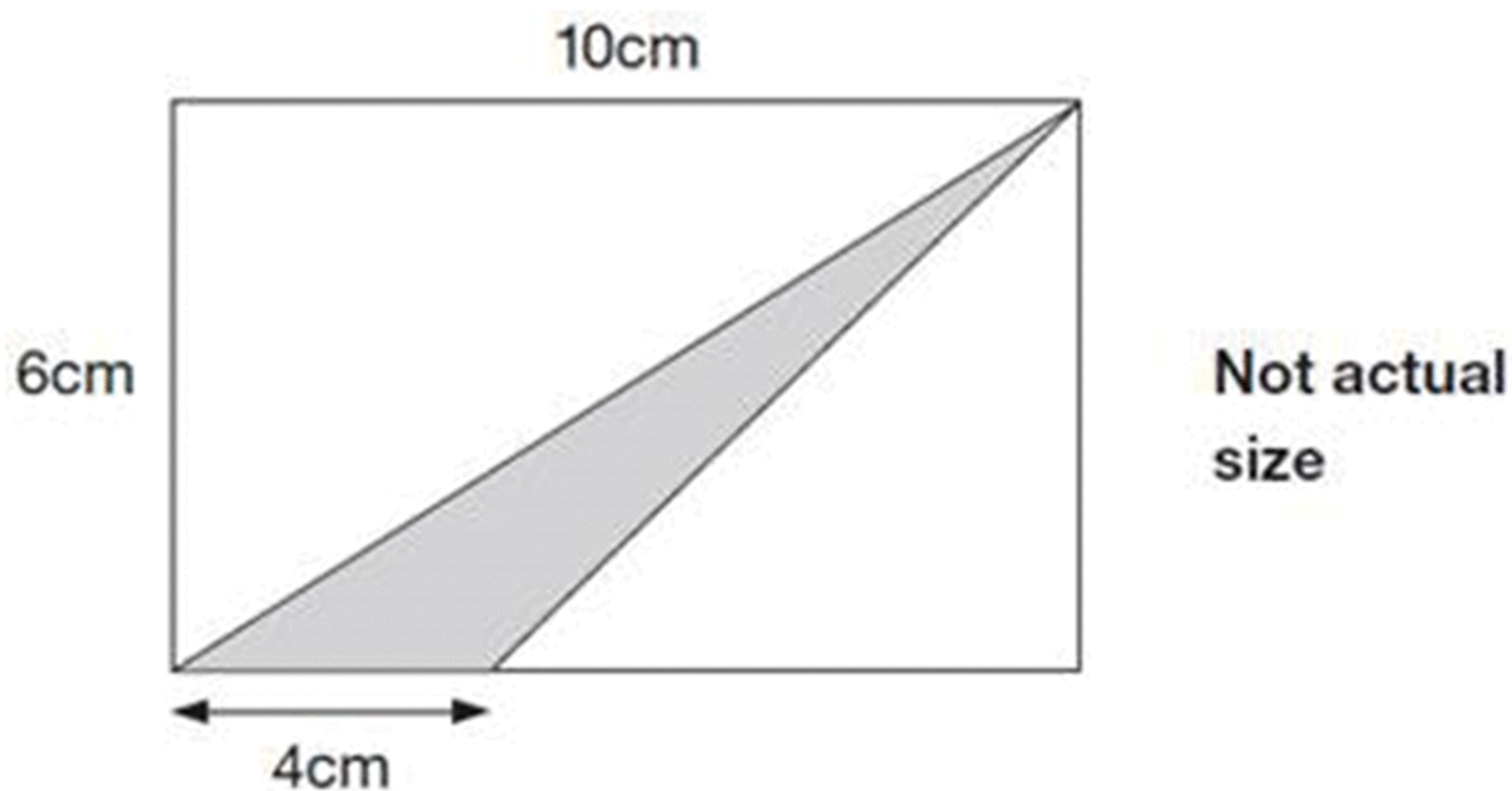

What is the area of the shaded triangle?

3 Liam thinks of a number.



He **multiplies the number by 5** and then **subtracts 60** from the result.

His answer equals the number he started with.

What was the number Liam started with?

Show your **working**.  
You may get a mark.

4 Alfie did a survey to find which soup was most popular.

The choices were:

- tomato
- chicken
- mushroom

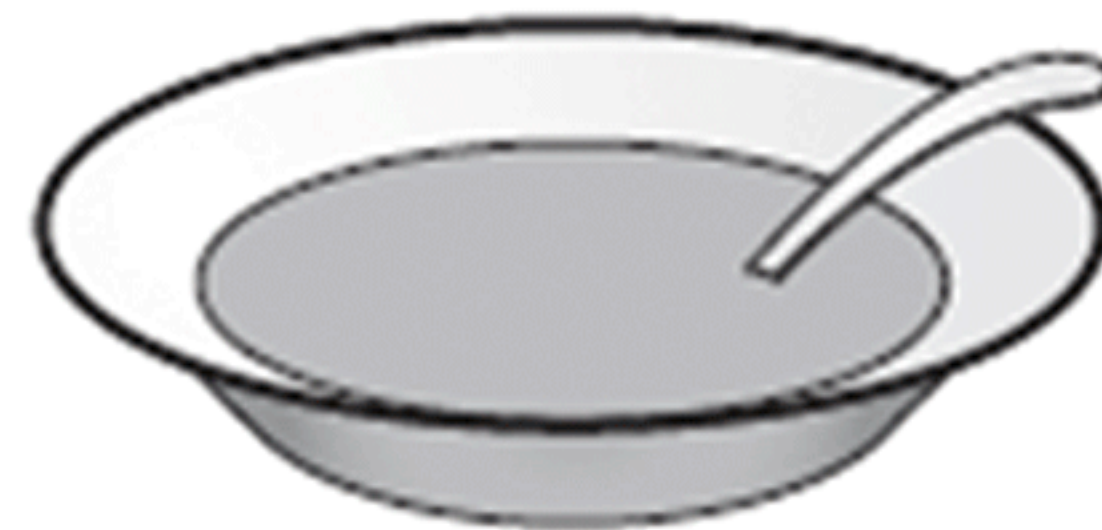

A quarter of the children chose chicken soup.

Four times as many children chose tomato soup as chose mushroom soup.

Alfie makes a pie chart to show this information.

What **angle** should he use for the children who chose tomato soup?

# Day 9 - Reasoning



1 A shaded **isosceles** triangle is drawn inside a rectangle.

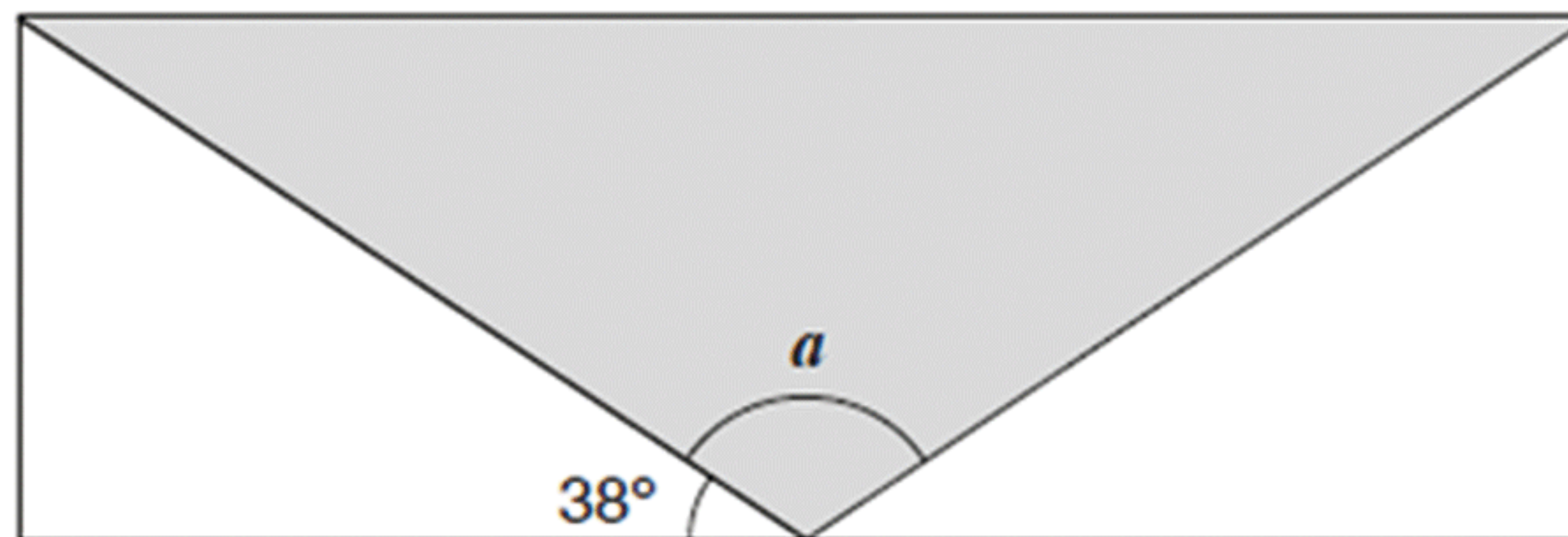

Not  
to  
scale

Calculate the size of angle  $a$ .

Show your method

2 Three-quarters of a number is **48**

What is the number?



3 Here is an equilateral triangle inside a square.

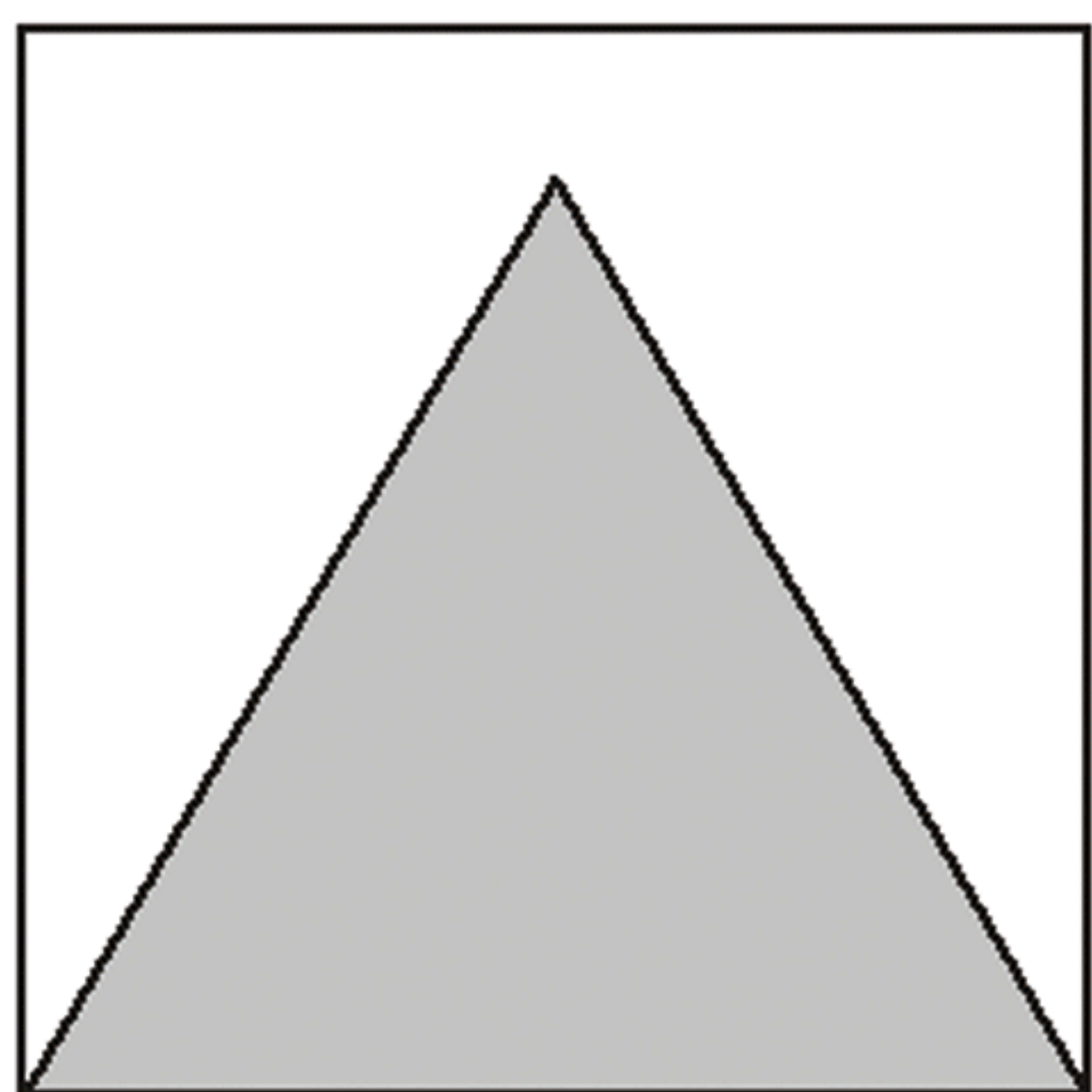

Not actual size

The perimeter of the triangle is 48 centimetres.

What is the perimeter of the **square**?

4 Here is a sequence of shapes.

Each time a square is added to a shape, two more circles are added.

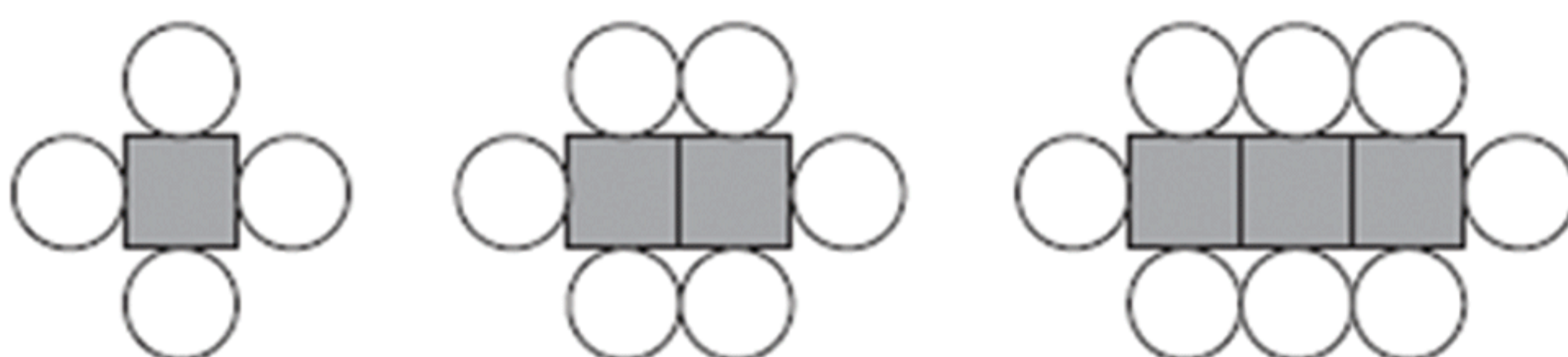

number of squares, <b>s</b>	1	2	3
number of circles, <b>c</b>	4	6	8

The sequence of shapes continues.

The formula for the sequence is  **$c = 2s + 2$**

Calculate the number of circles when the number of squares in a shape is **150**.

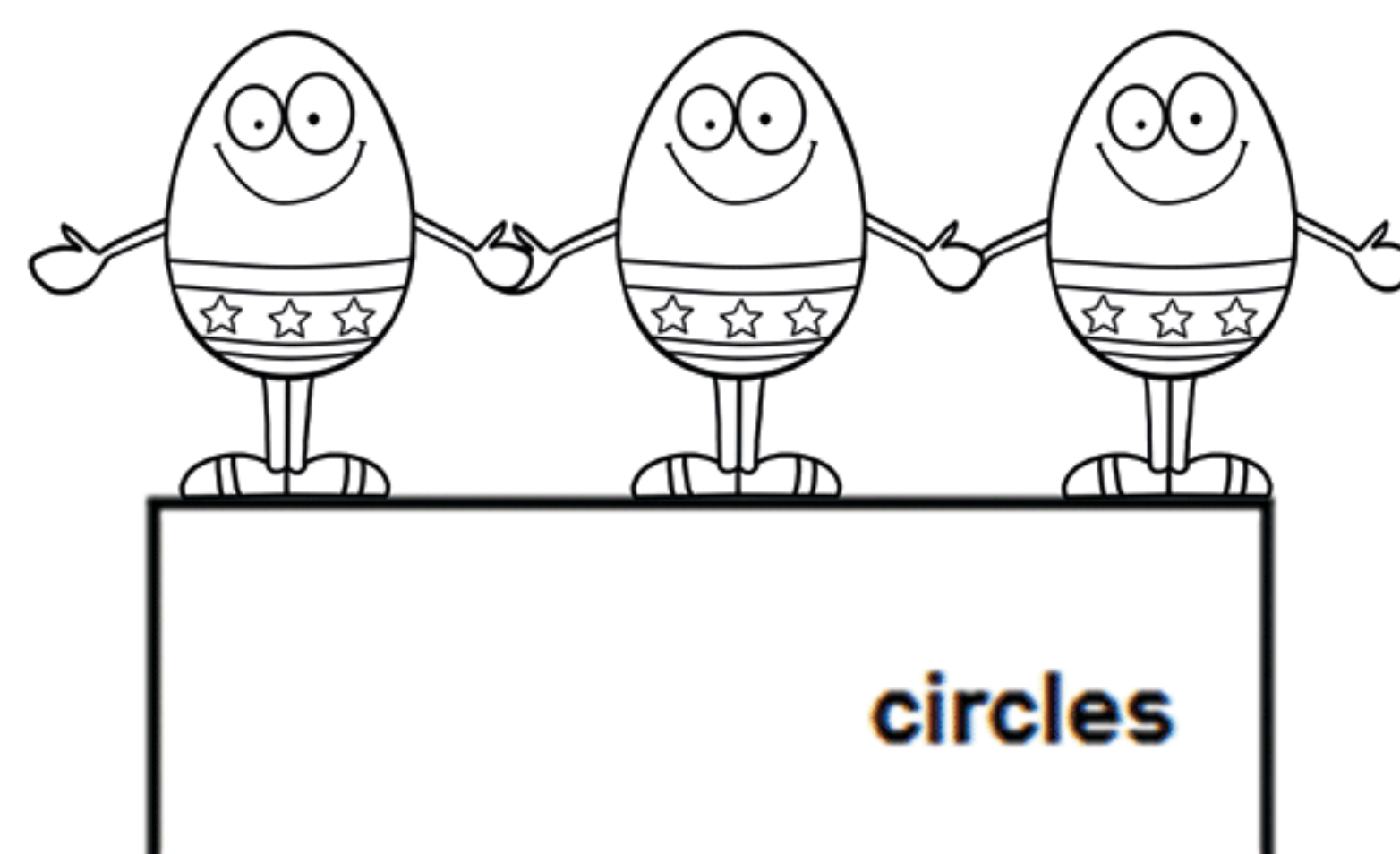

How many squares are there in a shape that has **100** circles?

# Day 10 - Reasoning



1 In this circle, each shaded part is  $\frac{1}{5}$  of the area of the circle.

The two white parts have equal areas.

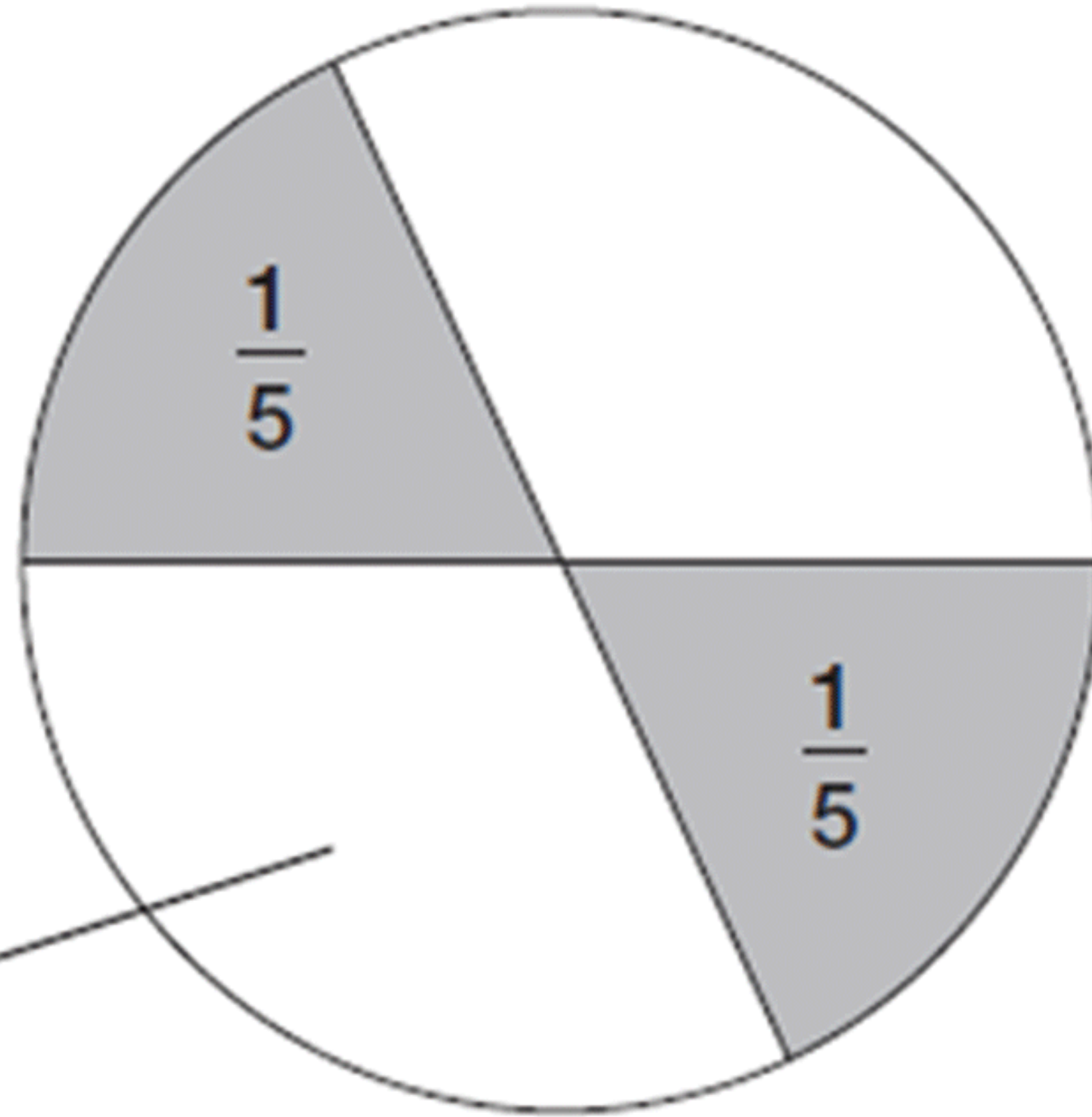

Not drawn accurately

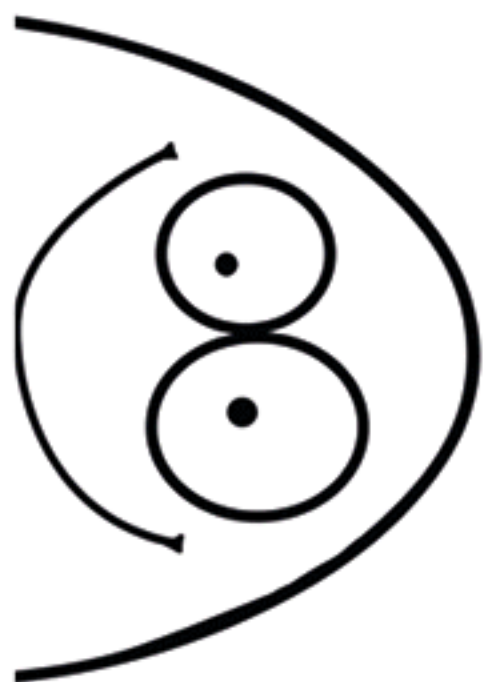

What fraction of the circle is **one** of the white areas?

2 Write in the missing number.

 50  $\div$   = 2.5

3 20% of the children in a sports club play tennis.



25% of the children who play tennis **also** play rounders.



There are 8 children in the club who play **both** tennis and rounders.  
How many children are there in the sports club **altogether**?

4 Debbie has a pack of cards numbered from 1 to 20

She picks four different number cards.

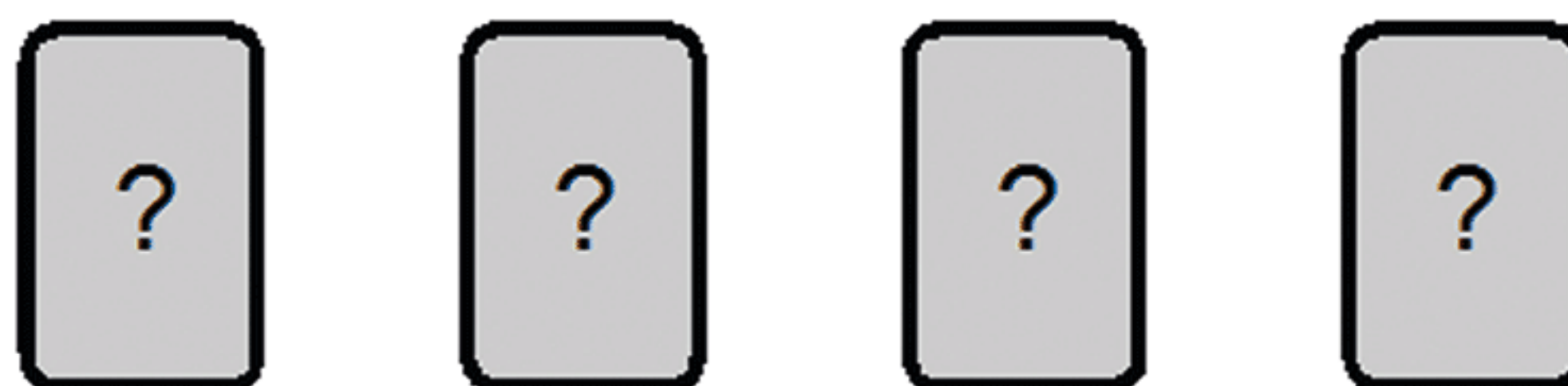

Exactly three of the four numbers are multiples of 5

Exactly three of the four numbers are even numbers.

All four of the numbers add up to less than 40

Write what the numbers could be.

A small pencil icon is positioned to the left of four empty rectangular boxes with rounded corners, arranged in a horizontal row.

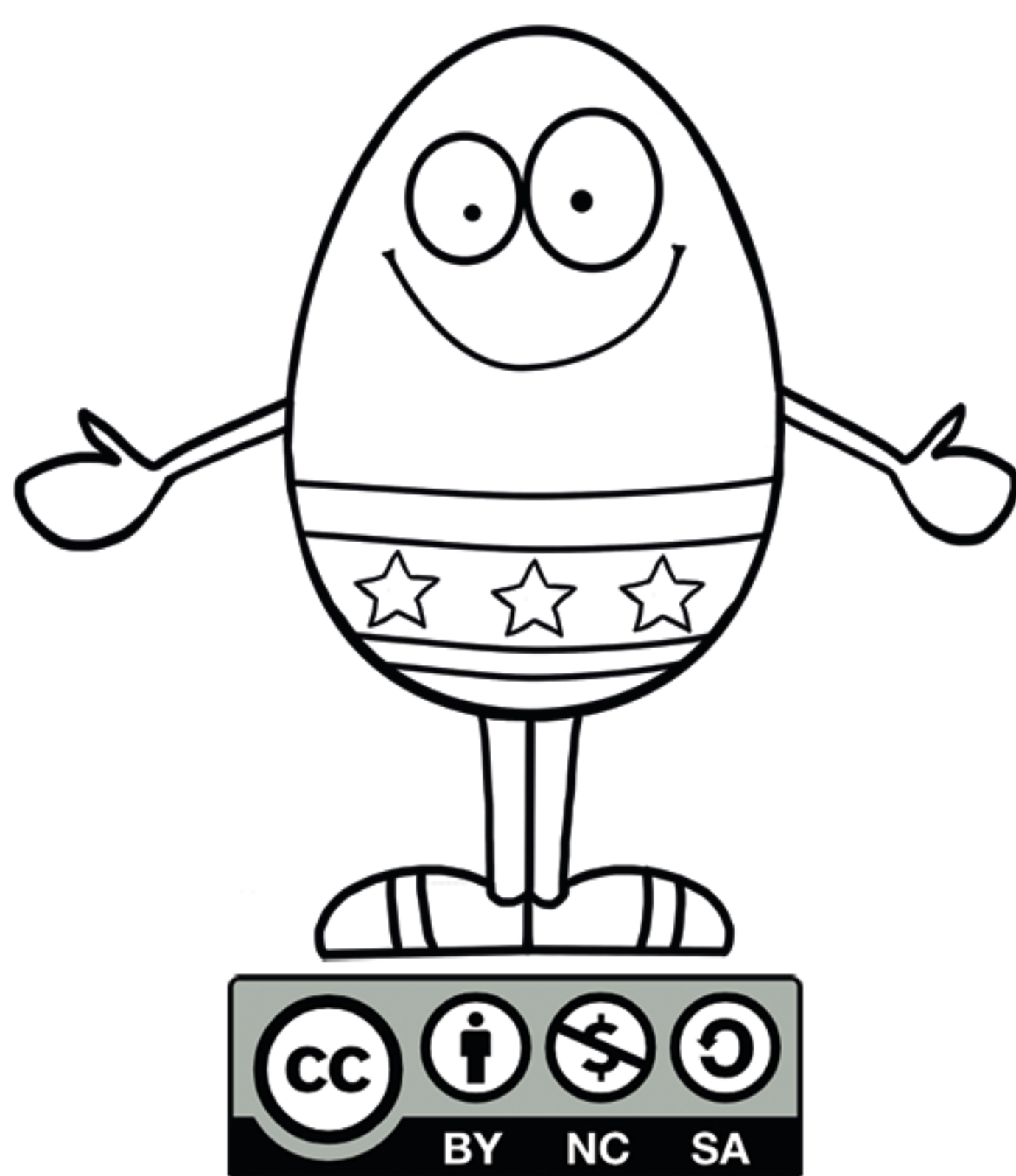

For source files visit: <http://bit.ly/2muSRIX>

Ten for Ten KS2 Mathematics - Easter Practice Booklet by Nyima Drayang is licensed under a Creative Commons Attribution-NonCommercial-ShareAlike 4.0 International License. Permissions beyond the scope of this license may be available at <https://twitter.com/LttMaths>